

TONE

every cup has its own TONE



TOUCH
03



DIGITAL MANUAL

Please get in touch with your dealer for any information about the software or first instructions.

DECEMBER 2021
VERSION 1.3

INSTALLATION AND USER INSTRUCTIONS

DISCLAIMER

Congratulations on purchasing your new TONE product. The information in this document affects your safety and your legal rights and responsibilities. Read this entire document carefully to ensure proper configuration before use. Failure to read and follow instructions and warnings in this document may result in serious injury to yourself or others, damage to your TONE product, or damage to other objects in the vicinity. This document and all other collateral documents are subject to change at the sole discretion of TONE. For up-to-date product information, visit <http://www.tone-swiss.com> and click on the product page for this product.

By using this product, you hereby signify that you have read this disclaimer and warning carefully and that you understand and agree to abide by the terms and conditions herein. You agree that you are solely responsible for your own conduct while using this product, and for any consequences thereof. You agree to use this product only for purposes that are proper and in accordance with all applicable laws, rules, and regulations, and all terms, precautions, practices, policies and guidelines TONE has made and may make available.

TONE accepts no liability for damage, injury or any legal responsibility incurred directly or indirectly from the use of this product. The user shall observe safe and lawful practices including, but not limited to, those set forth in this document.

Copyright © 2021 by TONE Kaffeemaschinen AG

All rights reserved. No part of this publication may be reproduced, distributed, or transmitted in any form or by any means, including photocopying, recording, or other electronic or mechanical methods, without the prior written permission of the publisher. For permission requests, write to the publisher, addressed at the address below.

TONE Kaffeemaschinen AG
Kasernenstrasse 5
3600 Thun
Switzerland

Manufacturer:
Thuner Kaffeemaschinenfabrik GmbH
Kasernenstrasse 5
3600 Thun / Switzerland

+41 52 620 06 06
contact@tone-swiss.com
www.tone-swiss.com

TRADEMARKS

TONE is a trademark of TONE Kaffeemaschinen AG (abbreviated as „TONE“) and its affiliated companies. Names of products, brands, etc.. appearing in this manual are trademarks or registered trademarks of their respective owner companies.



TABLE OF CONTENTS

1. PROPER USE	6
1.1 For your safety	6
1.2 Explanation of safety warnings	6
2. DESCRIPTION OF THE PRODUCT	8
2.1 Purpose of the Product	8
2.2 Contents	8
2.3 Appliance overview	8
2.4 Dimensions	9
3. INITIAL USE	10
3.1 Place of use	10
3.2 Pumping Connection	10
3.3 Electrical Connection	10
3.4 Initial set-up	11
4. PROCESS/WORKFLOW	11
4.1 Brewing	11
4.2 Button Function	11
4.3 Connection	12
4.4 Edit recipes	14
4.5 Advance	17
4.6 Service	18
5. MAINTENANCE	18
5.1 Cleaning	19
5.2 Daily Cleaning	19
5.3 Descaling	19
5.4 TOUCH 03 Equipment	19
6. FAULT RECTIFICATION	20
7. TECHNICAL DATA	21
8. RECYCLING AND DISPOSAL	21
9. WARRANTY	21
10. WIRING DIAGRAM	22
11. WATER SPECIFICATION	23
OPTIONAL FILTER STAND	24
DECLARATION OF CONFORMITY	26

1. PROPER USE

This machine is only intended for the use for which it was basically developed. Any other use shall be considered ill-suited and improper. The manufacturer shall not be considered responsible for any damages caused by improper use. The electric safety to the machine is achieved only when the machine is correctly connected to a grounded electric system.

This fundamental requirement shall be assessed by qualified personnel. Manufacturer and installer shall not be held responsible for any damages caused by the lack or inefficiency of system grounding.

1.1 FOR YOUR SAFETY

Read and follow the instructions in these operating instructions in order to operate this machine safely. Do not carry out any independent modifications or repairs on the device.

The following warning symbols are used in these operating instructions.

1.2 EXPLANATION OF SAFETY WARNINGS



DANGER!

Failure to observe the warning can result in danger to life and limb.



WARNING!

Failure to observe the warning can result in material damage.



CAUTION!

Matters which should be taken into account when using the appliance.



INFORMATION FOR CORRECT DISPOSAL OF THE PRODUCT IN ACCORDANCE WITH EC DIRECTIVE 2012/19/EU



This product must not be disposed of as urban waste at the end of its working life. It must be taken to a special waste collection centre licensed by local authorities or to a dealer providing this service. Separate disposal of the product will avoid possible negative consequences for the environment and for health resulting from inappropriate disposal, and will enable the constituent materials to be recovered, with significant savings in energy and resources.

Separate disposal of the product will avoid possible negative consequences for the environment and for health resulting from inappropriate disposal, and will enable the constituent materials to be recovered, with significant savings in energy and resources.

OBSERVE THE FOLLOWING SAFETY INSTRUCTIONS AT ALL TIMES:

- The appliance is only to be installed in locations where its use and maintenance is restricted to trained personal.



DANGERS TO CHILDREN AND OTHER PERSONS!

Children should be supervised in order to ensure that they do not play with the appliance.

- This appliance is not intended for use by persons (including children) with reduced physical and mental capabilities, or lack of experience and knowledge, unless they have been given supervision or instruction concerning use of the appliance by a person responsible for their safety.



DANGER DUE TO FAULTY OPERATION!

Improper use of the appliance can result in damage or injury.

- Do not use the appliance barefoot or when hands / feet are wet.
- Unplug the appliance from the electric system and turn off water supply before carrying out any cleaning and ordinary maintenance.
- Do not put the appliance under a jet of water, nor plunge it into water to clean it.
- Do not leave the appliance turned-on and unattended for long periods (e.g. 1 day)

- In order to ensure the efficiency and correct functioning of the appliance, it is necessary to follow the instructions provided by the manufacturer and to carry out its ordinary maintenance.

- The appliance shall be installed so that the highest surface is at least 1 metre high.

- The appliance shall be placed on a level horizontal surface to ensure a safe use.

- The temperature range of the environment surrounding the appliance shall be included between 5°C and 30°C. In case the appliance is temporarily placed in an environment where the temperature is below 0°C, contact a local Technical Service authorized by the manufacturer.

- The machine shall be placed on a surface guaranteeing secure support.

- Ideally the appliance is bolted onto the working surface using a pair of slotted countersunk screws (M8, stainless).

- The machine must be connected exclusively to an appropriate cold drinking water source, in compliance with national norms and rules. The pressure of the incoming water must be between 0.15-0.3 MPa. If this does not meet, install a pressure reducer / regulator according to the requirements.

- A shut-on tap must be installed between machine water hose and water system to block water flow in case of necessity.

- When installing the appliance, use exclusively the current hose-set provided with the appliance itself.

- In case of appliance breakdown and/or malfunctioning, turn the main switch OFF and refrain from trying to repair it. Then contact a local Technical Service that has been authorized by the manufacturer.



WARNING DUE TO UNAUTHORISED REPAIR!
Faulty repairs can result in damage to the appliance.

- Repairs should be carried out only by authorised customer service centres.

- If you cannot correct a fault with the aid of the steps described in these operating instructions, please refer to your authorised dealer.

- The electric safety of the machine is achieved only when the machine is correctly connected to a grounded electric system.

- The user shall arrange electric, water and draining systems in a suitable position to allow correct machine installation.



WARNING BEFORE SERVICING OR OPENING

this device make sure the brewer is disconnected from power by pulling its plug. The service technician has to see

the pulled plug during the whole service operation.

- The installer cannot modify the existing system built by the user.

- If the electric supply plug is damaged, it must be replaced by another plug provided by the manufacturer or by its Technical Service.

- For good machine functioning and maintenance, it might be necessary to install a water softener in order to avoid scale formation. This must be evaluated by the installer and the user shall leave a space for the correct installation of a water softener, following the instructions contained in its manual.



Do not use water jet devices in the area where TOUCH 03 is installed!



Do NOT tilt TOUCH 03 during operation! Max. tilt angle < 5°.



Only to be operated by trained personnel!

2. DESCRIPTION OF THE PRODUCT

2.1 Purpose of the Product

This machine shall be destined exclusively to the use it has been expressly designed for. Any other use shall be considered illsuited and improper.

2.2 Contents

- 1x TOUCH O3 Machine
- 1x Manual Touch O3
- 1x Grey magnet
- 1x Second spray head



2.3 APPLIANCE OVERVIEW

- 01 Power switch (on back side)
- 02 Four programmable buttons
- 03 Spray head

- 04 stand for smaller brewing vessels (optional)
- 05 Drip tray



CAUTION
 Improper electrical installation will damage electronic components. Damage caused by incorrect electrical connections is not covered by warranty.



CAUTION
 Power to brewer must be OFF before proceeding with plumbing installation.

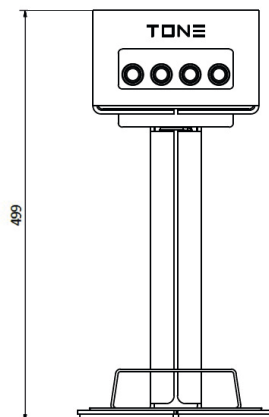

Cold Water | Softener

Ethernet connection cable

Powercord
 P | N | GR

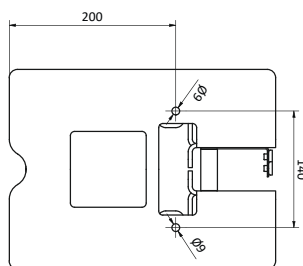
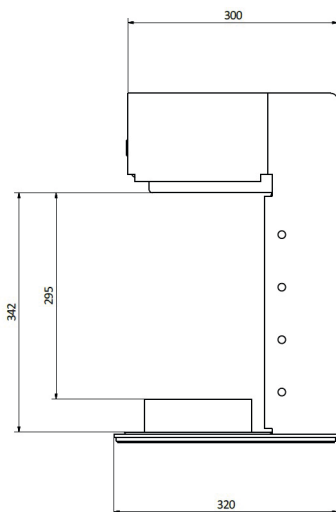

3. INITIAL USE

Before using your TONE Touch O3

3.1 PLACE OF USE

Brewer should be installed only inside and in a dry environment. Brewer should be installed on a secure, level, surface capable of fully supporting the weight of the brewer, including the water retained in the brewer, and any fully loaded dispenser(s) that may be placed on the brewer.

- A potable water line (cold water) capable of consistently supplying the required minimum flow rate within the noted pressure range is required at the install location.
- A grounded electrical connection to a circuit that meets the electrical specifications of the brewer and is protected by the appropriate size and type of breaker is required. See the supply cable specification in chapter 3.3.



CAUTION

Power to brewer must be off before proceeding with plumbing installation.



CAUTION

Improper electrical installation will damage electronic components. Damage caused by incorrect electrical connections is not covered by warranty.

3.2 PLUMBING CONNECTION

- The brewer must be rinsed after being connected to the water supply line. Remaining air in the system will be removed. Otherwise it may lead to malfunctions and noise in the housing. Follow instructions in section Button functions.
- The pressure of the water line must be within 1.5 bar - 3 bar.

- The installation of a water softening filter system is mandatory for the use of TONE equipment. Any violation of this regulation will lead to a complete loss of any warranty on the complete system.
- The brewer has a descaling tracking function available. Follow the instructions on page 19.

3.3 ELECTRICAL CONNECTION



WARNING

The brewer must be disconnected from the power source until specified in INITIAL SET-UP.



CAUTION

Improper electrical installation will damage electronic components. Damage caused by incorrect electrical connections is not covered by warranty.

- An electrician must provide electrical service as specified in conformance with all local, state and federal electrical codes.
- Specification of the required electric supply cable: 3x AWG 13 (cross section 2.63mm²) according to local regulations.
- Use a voltmeter to check the voltage and color coding of each conductor at the electrical source.
- Ensure power switch on rear of brewer is in the off position. Connect brewer to power source and verify voltage at terminal block. Replace rear panel and top cover. If plumbing has been hooked up, brewer is ready for Initial Set-Up. If not, disconnect brewer from power source.



WARNING

Electrical connections must be made as specified above. Failure to follow these instructions can result in personal injury, property or equipment damage.



WARNING

Before servicing or opening this device make sure the brewer is disconnected from power by pulling its plug. The service technician has

to see the pulled plug during the whole service operation.

This device must be connected to a line system impedance $Z_{sys} \leq 0.082 + j0.051 \Omega$

Symbol explanation:

I = Input

O = Output

Consult the supply authority before connecting.

3.4 INITIAL SET-UP

- Remove the grey cover from the housing.
- Connect the blue water house with the Touch O3 and your water supply. (*Note: The TONE Touch O3 needs to be run with filtered water*)
- The water pressure should be between 0.15 and maximum 0.3 MPa (the flow of the machine is calibrated at the factory with 0.23 MPa). If you have a standard water pressure which is higher than 0.3 MPa you need to install a pressure regulator.
- The delivered connection adapter from TONE has a 3/8 inch thread.
- Plug the machine into the 230 V socket.
- Build up a connection with a laptop or tablet to your Touch O3. Connection by ethernet cable to your laptop or connection by ethernet cable to a lan switch or connection over wifi with the IO-GEAR device. (*Note: Required operating system on your pc or laptop is **WINDOWS 10***)
- Rinse the machine by pushing the buttons 1 & 2 and the main switch (the two buttons will shine up blue and cold water will rinse through the machine until you switch off the machine). This will help to get rid of the air inside of the brewer system.
- Calibrate the flow of the machine to its new home. See section 4.6

4. PROCESS/WORKFLOW

4.1 BREWING

Equip a brewing vessel of your choice with a filter and fill in an appropriate amount of brewing ingredients.

Place the brewing vessel with loaded filter underneath the spray head and select the desired recipe by pushing the corresponding button. As soon as the program is running the button starts to blink. Be aware that the water flow may be interrupted during the brewing process once or several times. Wait until the recipe is processed completely (button stops to blink).

Remove the brewing vessel from the appliance and the TONE Touch O3 is ready for use again immediately. The program can be aborted by pushing the chosen button again during process.

There are four factory standard recipes installed on every Touch O3 (from left to right):

- | | | |
|----------|---------------|---------------|
| 1 | Volume: 300ml | Taste: mild |
| 2 | Volume: 300ml | Taste: medium |
| 3 | Volume: 300ml | Taste: bold |
| 4 | Volume: 300ml | Taste: xbold |

The recipes can be exchanged or modified by connecting the TONE Tablet PC to the TOUCH O3. The TONE Tablet pc is an optionally available device, which can be purchased directly from TONE or any qualified service partner. It is also possible to order new settings as a part of a service operation.

4.2 BUTTON FUNCTION

Recipe selection:

Button 1 - 4 (from left to right)

Descaling:

Push and hold Button 1 while switching the main switch ON

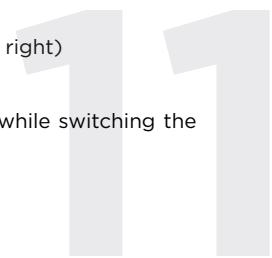

Rinsing:

Push and hold button 1 & 2 while switching the main switch ON. Stop the rinsing by switching the main switch OFF

- Rinse the device after a long-lasting down time or when there may be air inside the system.
- Before air transport or exposure to temperatures below 4°C all remaining water inside the brewer has to be removed. Disconnect the water supply and start the rinsing procedure. Insert an air-loaded syringe into the waterline and carefully push all remaining water out.

NEVER USE COMPRESSED AIR! This will destroy the sensitive flow meter.



Buttons 1 & 4 light up blue

- NTC thermal sensor disconnected
- Contact the customer support.



Button 1 & 3 & 4 light up blue

- Brewer overheated. The machine needs to be rinsed (button function / rinsing)
- E-Fast sensor disconnected
- If you have the firmware 2.6.0 on your Touch O3 please do a downgrade to 2.5.0
- Check the FTH Fuse if defective
- Check all cable connection on top of the heating element
- Contact the customer support



Buttons 3 & 4 light up blue

- No flow/ water supply interrupted (Heating element can overheat) flow meter defective
- Check water supply. Otherwise contact the customer support.



Buttons 2 & 4 light up blue

- Proportional valve is leaking
- Contact the customer support.



Buttons 2 & 3 & 4 light up blue

- Brewer overheated/ error on heating element/ defective thermostat / Flow problem not resolved/
- Switch brewer OFF and let it cool down. This can be accelerated by rinsing with cold water (s. Button Functions -> Rinsing).
- Heating element does not reach target temperature

For more precise informations go to page 20. Otherwise contact the customer support.

Trouble shooting

If vibrating noises are heard from the machine housing, there could be air in the system. This can be the case in particular if the water supply line has been interrupted. In order to remedy the fault, the device must be rinsed. Follow the instructions in the section Button Functions.

In case of any other issues, please contact your service partner. A replacement of the Blackbox might be necessary.

4.3 CONNECTING

OPTION 1 A

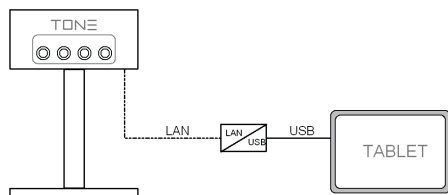

Direct Connection

(direct or via a LAN-2-USB Converter)

- connect the TONE to the tablet / pc
- or
- connect the TONE via the LAN-2-USB converter to your tablet / pc

- only one TONE can be connected to the tablet / pc

OPTION 1B

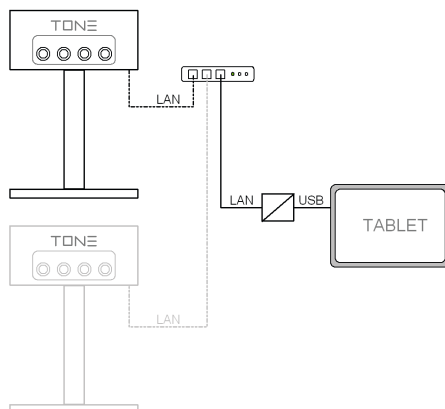

LAN-Switch / LAN-router

- connect the TONE to the LAN switch
- connect the LAN switch to the tablet / pc (direct or via LAN-2-USB converter)
- you can connect one or more TONE to the tablet / pc

NOTE:

The ethernet port configuration on your tablet / pc should be as follow:

1. connect the cable direct to your device or via the LAN-2-USB converter
2. Open the ethernet properties
Control panel - Network and internet
- Network and sharing center- change adapter settings - ethernet - properties
3. Click on Internet protocol version 4 (TCP/ Pv4) - properties
4. Select "obtain an IP adress automatically"

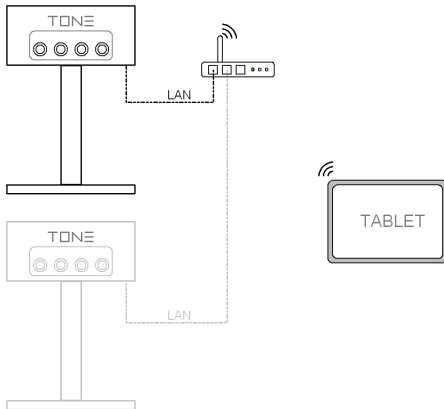
OPTION 2A**Wifi-Router**

- connect the TONE to the wifi router
- connect the tablet / pc to the wifi router
- you can connect one or more TONE to the tablet / pc

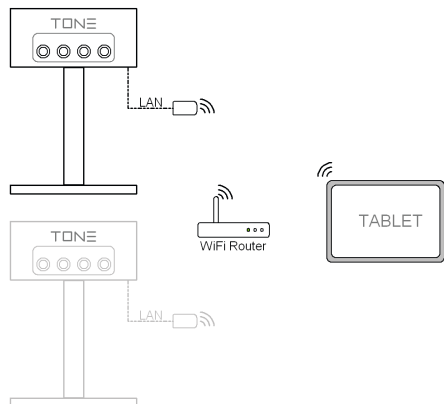
OPTION 2B**Ethernet-2-Wifi-Converter (IO-GEAR)**

For each TONE you need an Ethernet-2-Wifi-Converter

- Consider the specific manual / video for the set-up on www.tone-swiss.com

4.4 EDIT RECIPES

Connect your TONE Touch03 brewer with the TONE tablet computer as described in the previous section. Once the installation is complete, switch your TONE Touch 03 ON and it will appear in the list of available TONE equipment on the left side of the Touch03 tab. The factory pre-set name will be `ToneTouch03_XXXXX` (XXXXX=serial number). This can be customised later (s. Service tab).

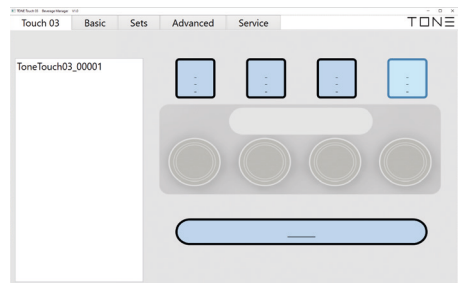

Click on your device in the list and the standard configuration of the recipe selection buttons will be displayed. You can either change this configuration by clicking each button individually and chose recipes from the list which will be explained later. Or you can select a whole set of recipes which you can compose in the Sets tab.

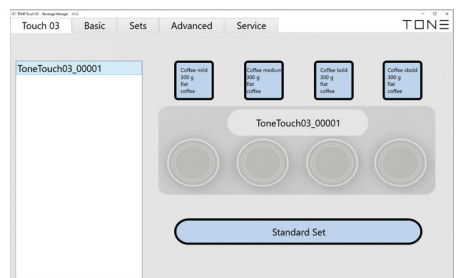

Please remark that your adaptations are made directly on the device. There is no need for a transfer command or a click on a confirmation checkbox here.

The Basic tab provides a tool for a quick and successful recipe creation. There are

four pre-set options for coffee and three for tea, which will result in different flavour intensities of the beverage.

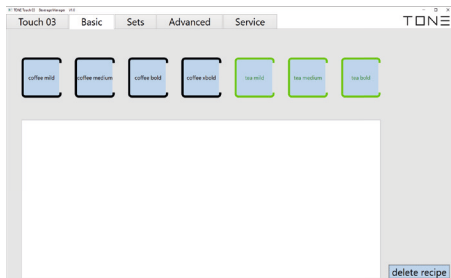

For the coffee recipes, the brewing temperature and the pulsation of the water flow is pre-defined, based on the experience of TONE coffee experts. You can simply adjust the amount of water (click or click and hold on the arrows) and choose between cone and flat filters. Make sure you have installed the correct spray head insert for each filter type. For the cones you need to install the insert with 5 holes, for the flat filter the insert with 18 holes.

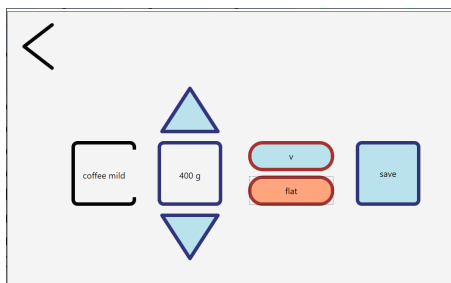

Click on the save button and your recipe will appear on the recipe list.

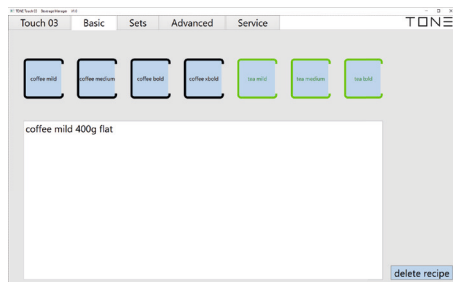

The name of the recipe tells you the strength of the coffee, the amount of water and the applied filter type.

The settings of the tea recipes are slightly different. Choose the water temperature considering the type of tea which shall be prepared. The colours of the button frames correspond to the tea types. The different tea options differ regarding the number of pulses and their characteristics.

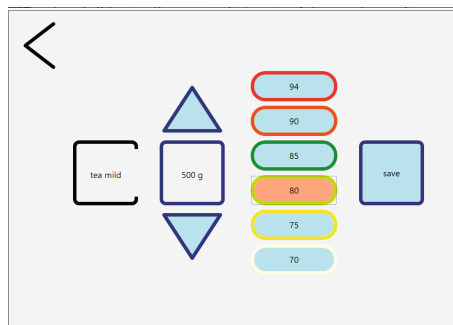

The name of a tea recipe will tell you the strength of the flavour, the amount of water and the brewing temperature.

See below a list of sample recipes for each pre-set button. When a recipe is no longer needed, you can delete it in this window by clicking "delete recipe".

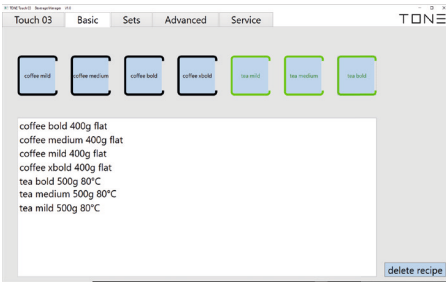

The Set tab is empty when used for the first time. You can compose a set of recipes by clicking on each of the four square buttons and choosing a recipe from the list.

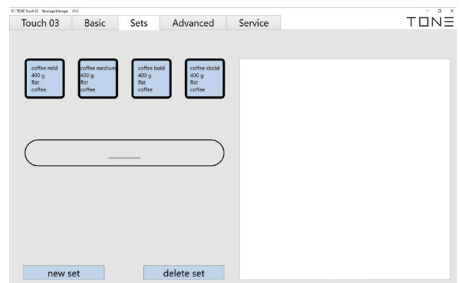
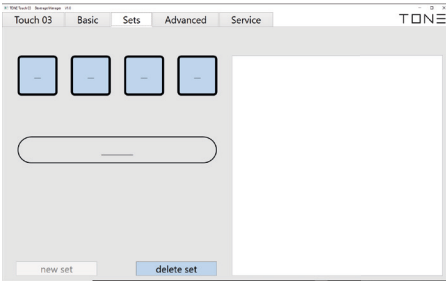
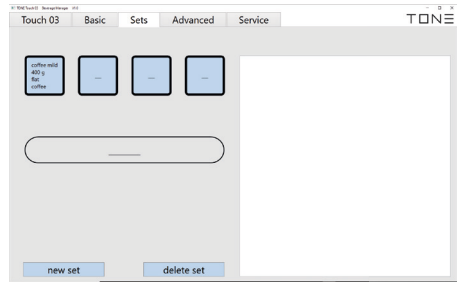

Once you have made your selection of recipes, click on the button “new set” and give it a meaningful name.

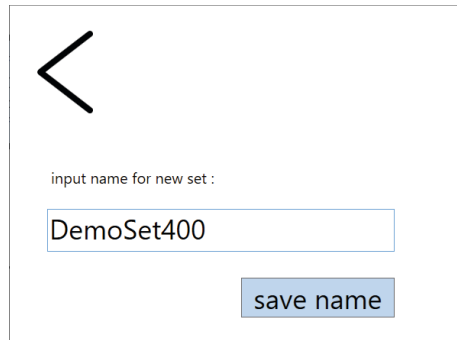
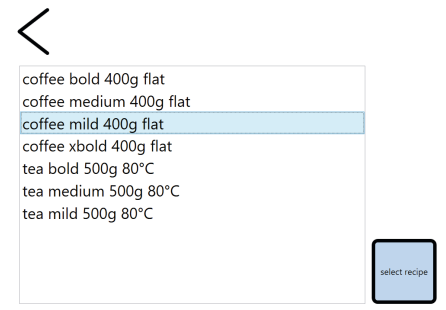

Your set then appears on the set list on the right side of the window. This list will be displayed when you click on the set bar in the Touch 03 tab. Sets which are not needed anymore can be deleted by clicking on “delete set”.

4.5 ADVANCE

The Advanced tab provides you a very intuitive and comprehensive tool for the creation of new recipes. You can set the temperature of each extraction phase (bloom, turbulence, development) and define the characteristics of the water pulses (quantity, flow ratio, duration, interval). Just drag the blue points in the corner of the pulses into the desired position. The current values will be displayed at the top the graphical input screen.

Dragging vertically will change the flow ratio. Dragging horizontally affects time-correlated features.

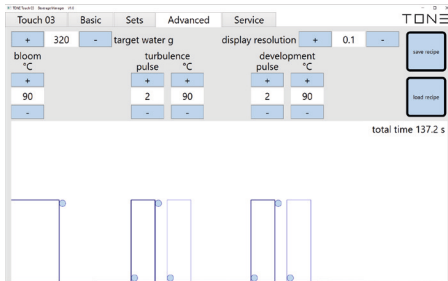

First of all, you should set the water target which you would like to produce. This value will not be exceeded. Varying the bloom or the turbulence phase will adapt the development phase automatically. The development phase itself is self-adjusting between duration and flow ratio of its pulses. Depending on how detailed you would like to compose your recipe, the display resolution can be set 1 or 0.1.

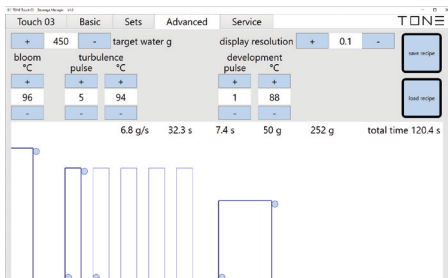

Once you have completed your recipe, you can save it by clicking “save recipe”. It will then appear in the selection lists in the Touch 03 and Sets tabs. The name of advanced recipes will be marked with „ad“ at the beginning, followed by a description, the weight and the intended filter type. There is also the possibility to change existing advanced recipes by clicking “load recipe”.

<

recipe description:

extraction volume:

vessel used:

<

4.6 SERVICE

The Service tab provides possibilities to customise the brewer identification and the calibration. And you can also check all important parameters. Clicking on the service tab will automatically open a login pop-up window. Entering the password “TONEservice” enables all available options. Select one of the brewers listed in the left column.

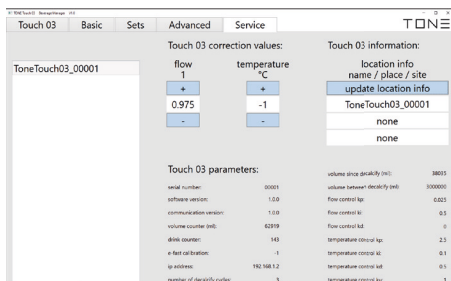

Click on “update location info”, enter a meaningful description of your brewer and its location and confirm these entries by clicking “accept”.

name of TONE Touch 03:

location info place:

location info site:

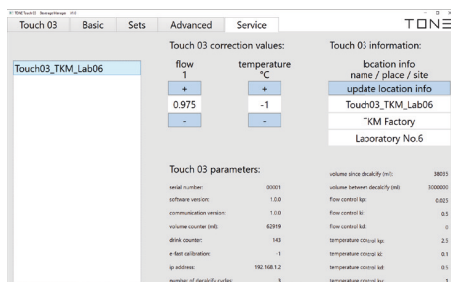

In case your brewer should extract more or less water than intended you can tweak the flow rate by setting a value below 1 in case you want to reduce the amount of water or a value above 1 if you want to increase the amount of water. This is a very sensitive tool an can only be adjusted in permille steps.

In case your extraction temperature doesn't fit to the set values of the recipes (e.g. when there is very cold water supply) you can adjust the temperature by clicking “+” or “-”. The maximum values are +5/-5°C. Keep in mind that the maximum possible temperature of a recipe is limited at 98°C. Theoretically you could then achieve a temperature of 103°C. The heating system will then produce steam instead of water, which needs to be prevented in order to achieve good brewing results. Please also remark that the boiling point of water drops with increasing altitude (ff -1°C/300m).

5. MAINTENANCE

5.1 CLEANING



DANGER due to improper cleaning!

Improper cleaning can result in damage to the appliance or personal injury.

- To guarantee proper functionality of TONE equipment it is necessary to clean the device on each day.

- To clean the surface of TONE equipment, it is recommended to use a damp cloth soaked in a 1% soda solution (Na_2CO_3).
- Never immerse the appliance itself, the power supply cable or plug in water.
- Never pull the plug out of the socket by the cable, always grasp the plug.
- Never attempt to touch or pick up and electrical appliance if it has fallen into water. In this case, disconnect the plug from the socket immediately.
- Check the appliance and cable regularly for damage.



DANGER due to unauthorised repair!

Repairs should be carried out only by authorised customer service centres.

- If you cannot correct a fault with the aid of the steps described in these operating instructions, please refer to your authorised dealer.

5.2 DAILY CLEANING

- Do not use water jet device to clean the TONE equipment.
- Do not use abrasive means to clean the TONE equipment.
- Check and clean the spray head daily. All holes of the spray head must always remain open

NOTE - Any remains on the sprayhead may influence the water flow and impact your coffee brewing.

5.3 DESCALING

To guarantee proper functionality of TONE equipment, it is necessary to descale the device. Descaling of TONE equipment may only be performed by qualified personnel. The descaling of the TONE Touch 03 brewing system is mandatory after every 2000 litres

of water extraction. Any violation of this regulation will lead to a complete loss of any warranty on the complete system.

The demand of a descaling process is indicated on the recipe buttons by a blue chasing light: -> <- ->.



Blue chasing light (Button 1-4) after switching the brewer ON and after finishing a recipe

- Descaling necessary

This signal is shown after switching the machine ON and at the end of every extraction. It will only disappear after a complete descaling process. Before the descaling process is started, a vessel with a minimum volume of 1 litre must be placed underneath the shower. Install the descaling agent container on the machine's inlet.

To begin the descaling, the machine must be switched OFF. Push and hold button 1 while switching the machine ON again. The descaling process starts immediately and will last about 12 minutes. As soon as the descaling is completed, button 1 shines constantly blue. Remove the descaling agent container and restart the machine. Flush the whole system by extracting at least 300 gram of hot water. The TONE Touch 03 is then ready for the preparation of the next 2000 litres of water.

In case you need support or additional equipment (e.g. descaling agent containers), please contact a local Technical Service that has been authorized by the manufacturer.

5.4 TOUCH 03 EQUIPMENT

- stand for smaller brewing vessels (see picture on page No. 08)

6. FAULT RECTIFICATION

PROBLEM	TIP
Overheating (Buttons 1 & 4 light up blue)	NTC thermal sensor disconnected. Contact the customer support.
Buttons 3 & 4 light up blue	No flow / water supply interrupted (Heating element can overheat) Flow meter defective > check water supply. Otherwise contact the customer support.
Buttons 2 & 4 light up blue -> Proportional valve is leaking	Contact the customer support.
Buttons 2 & 3 & 4 light up blue Brewer overheated / error on heating element / defective thermostat / Flow problem not resolved / missing signal from solid state relay.	Switch brewer OFF and let it cool down. This can be accelerated by rinsing with cold water (Press Button 1, 2 and main switch together). Otherwise contact the customer support.
After switching on, the machine lets the water flow through without pushing any button before.	The proportional valve is blocked. Build out the valve and clean it properly (check video on www.tone-swiss.com)

PROBLEM	TIP
When starting a recipe, no water comes out of the machine (Buttons 3 & 4 light up blue)	Water supply interrupted First check water supply and build out and clean proportional Valve (check video on www.tone-swiss.com)
The machine is not visible in the TONE App (Connection is done by ethernet cable)	Check the regulations of your local firewall and tick the automatic mode in the ethernet properties of your electronic device
The machine is not visible in the TONE App (Connection is done over wifi with the IO-GEAR device)	Check the setup of the IO-GEAR device regarding the manual "IO-GEAR Setup" (check video and document on www.tone-swiss.com)
No recipes visible on the keys (TONE-App)	Reset of the machine needed (function 1/3/4 and main switch) > Contact the customer support.

EEC CONFORMITY DECLARATION ACT 2006/42/EC

The undersigned: TONE Kaffeemaschinen AG with premises at: Rheinweg 4, 8200 Schaffhausen, Switzerland

Declares that: The coffee machine has been projected and manufactured in conformity with Directive 2006/42/EC and relevant national law, in accordance with the following norm for conformity evaluation: UNI 9887, IPSEL rev. 95.

7. TECHNICAL DATA

Type	TONE TOUCH 03
Dimensions in mm (w x h x d)	242 x 505 x 324
Weight	22 kg
Power	-220-240V I 12A 50/60Hz
Required electric supply cable	3x AWG 13 (cross section 2.63 mm ²) according to local regulations
Boilervolume	boilerless
Maximal waterflow	8g/sek
Heating	3450 W
Required water pressure	0.15 - 0.3 MPa / 1.5 - 3 Bar
Maximal water pressure	0.6 MPa / 6bar
Noise level	< 50 dB

8. RECYCLING AND DISPOSAL

Instructions for the disposal of old products.

The WEEE Directive (Waste from electrical and electronic equipment; 2002/96/EG) was passed for the protection of human health and the environment, in order to ensure that old products are disposed of so as to make use of the best possible recovery and technical recycling possibilities.

Your product has been developed and manufactured from high-quality materials and components, which can be largely recovered and recycled. Do not dispose of the product as normal domestic waste. Please find your local collection points for electrical and electronic waste products, which are marked with this symbol:

Please make use of one of the following disposal possibilities:



1. Dispose of the complete product (including the cable, plug and accessories) at the relevant WEEE collection point.
2. If you are buying a replacement product, you can return the old appliance to the dealer. Under the WEEE Directive, retailers are obliged to take back such old appliances.

9. WARRANTY NOTE

TONE Kaffeemaschinen AG warrants equipment manufactured by it for 1 year parts and labor. Accessories and Dispensers 1 Year parts only. Electronic Circuit and Control Boards- 2 years parts, 1 year labor. Equipment manufactured by others and distributed by TONE - Please see original equipment manufacturers warranty, TONE Kaffeemaschinen AG will follow.

These warranty periods run from the date of sale TONE warrants that the equipment manufactured by it will be commercially free of defects in material and workmanship existing at the time of manufacture and appearing within the applicable warranty period. This warranty does not apply to any equipment, component or part that was not manufactured by TONE or that, in TONE's judgment, has been affected by misuse, neglect, alteration, improper installation or operation, relocation or reinstallation, improper maintenance or repair, incorrect voltage applied to the unit at any time, damage or casualty. This warranty does not apply to any equipment failures related to poor water quality, excessive lime and chlorine and non periodic cleaning and descaling. Warranty is null and void if muriatic or any other form of hydrochloric acid is used for cleaning or deliming. In addition, this warranty does not apply to replacement of items subject to normal use including but not limited to user replaceable parts such as faucet seat cups, sight gauge tubes, washers, o-rings, tubing, seals and gaskets.

This warranty is conditioned on the Buyer

1) giving TONE Kaffeemaschinen AG prompt notice of any claim to be made under this warranty by telephone at +41 52 620 06 06 or by mail to service@tone-swiss.com;

2) if requested by TONE Kaffeemaschinen AG, shipping the defective equipment prepaid to an authorized TONE Kaffeemaschinen AG service location; and

3) receiving prior authorization from TONE Kaffeemaschinen AG that the defective equipment is under warranty.

THE FOREGOING WARRANTY IS EXCLUSIVE AND IS IN LIEU OF ANY OTHER WARRANTY, WRITTEN OR ORAL, EXPRESS OR IMPLIED, INCLUDING, BUT NOT LIMITED TO, ANY IMPLIED WARRANTY OF EITHER MERCHANTABILITY OR FITNESS FOR A PARTICULAR PURPOSE.

The agents, dealers or employees of TONE Kaffeemaschinen AG are not authorized to make modifications to this warranty or to make additional warranties that are binding on TONE Kaffeemaschinen AG. Accordingly, statements by such individuals, whether oral or written, do not constitute warranties and should not be relied upon.

If TONE Kaffeemaschinen AG determines in

its sole discretion that the equipment does not conform to the warranty, TONE Kaffeemaschinen AG, at its exclusive option while the equipment is under warranty, shall either

1) provide at no charge replacement parts and/or labor (during the applicable parts and labor warranty periods specified above) to repair the defective components, provided that this repair is done by a TONE Kaffeemaschinen AG Authorized Service Representative; or

2) shall replace the equipment or refund the purchase price for the equipment.

THE BUYER'S REMEDY AGAINST TONE KAFFEEMASCHINEN AG FOR THE BREACH OF ANY OBLIGATION ARISING OUT OF THE SALE OF THIS EQUIPMENT, WHETHER DERIVED FROM WARRANTY OR OTHERWISE, SHALL BE LIMITED, AT NEWCO'S SOLE OPTION AS SPECIFIED HEREIN, TO REPAIR, REPLACEMENT OR REFUND.

In no event shall TONE Kaffeemaschinen AG be liable for any other damage or loss, including, but not limited to, lost profits, lost sales, loss of use of equipment, claims of Buyer's customers, cost of capital, cost of down time, cost of substitute equipment, facilities or services, or any other special, incidental or consequential damages.

10. WIRING DIAGRAM

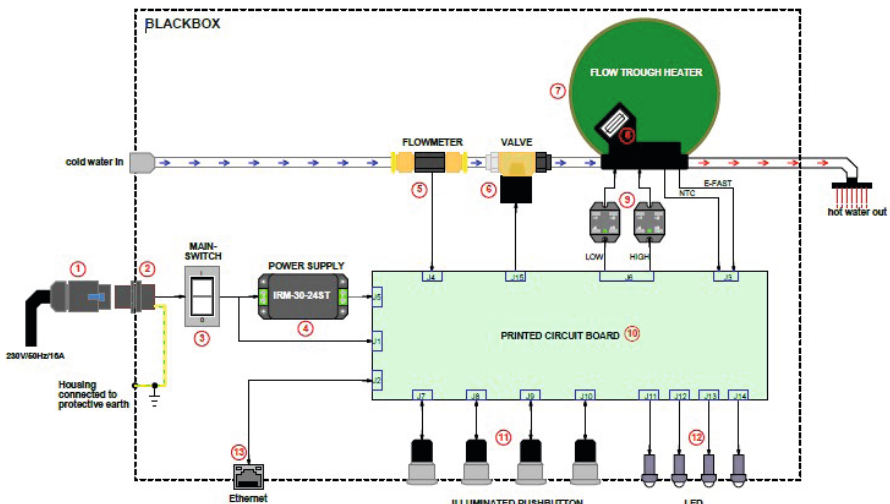

11. TONE WATER SPECIFICATION**Recommended water parameters for TONE TOUCH 03**

VALUE	UNITS	MINIMUM	MAXIMUM
Conductivity/T.D.S	µS ppm	120 60	400 220
Total Hardness	ppm °dH	50 3	160 9
Total Iron	ppm		0,2 mg/l
Free Chlorine	ppm	free from chlorine and chlorine compounds	
Total Chlorine	ppm		
pH		6	8
Alkalinity	ppm	36	107
Carbonate Hardness	°dH	2	6
Chloride	ppm	0	50

Required water pressure : 1.5 - 3 bar (20 - 45 psi / 150-300kPa)

IRON: Iron is regulated via the drinking water ordinance with 0.2 mg/L

CHLORINE: Even small amounts of chlorine can lead to a change in taste

CARBONATE HARDNESS: Depending on the coffee; recommendation: individual tasting during set-up and subsequent fine-tuning of the filter blend, as the KH has the greatest influence.

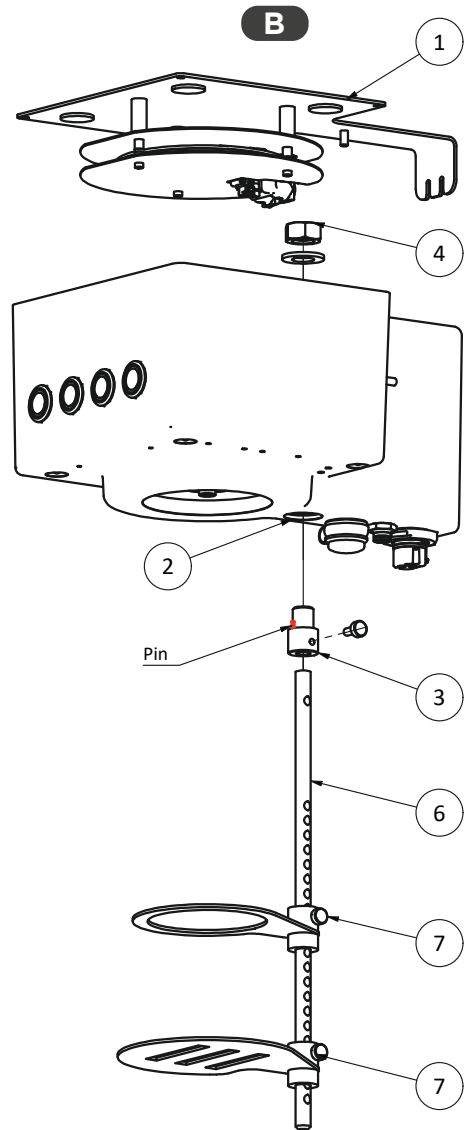
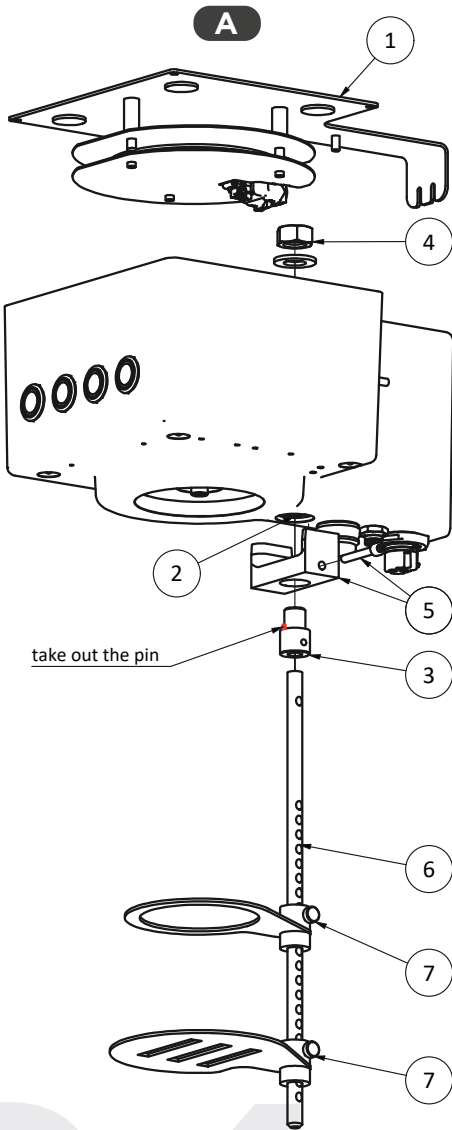

INSTRUCTIONS FOR MOUNTING THE FILTER STAND

This manual is only required if you install the option “Filter Stand” later to the purchase of the TOUCH 03

Version A “Blackbox without a groove”

- Remove the black lid from the black box (No.1)
- Remove the little black cap (No.2)
- Take away the little pin out of the screw (No.3) (pin is only needed for Version B)
- Fix the screw (No.3) with the washer and the 22mm nut (No.4)
- Before you tight it all the way orientate the screw with the alignment tool and the cylinder head screw (No.5)
- Tight the nut firmly (No.4, note that the screw does not rotate in the process)
- Loose the alignment tool and store it in a known place
- Insert the filter stand and fasten it with the knurled screw in the hole provided (No.6)
- Choose the desired height for both platforms (No.7)
- Brew some amazing coffee

Version B “Blackbox with a groove”

- Remove the black lid from the black box (No.1)
- Remove the little black cap (No.2)
- Fix the screw with the washer and the 22mm nut (No.4)
- Before you tight it all the way make sure the small pin (No.3) is located in the provided groove
- Tight the nut firmly (No.4, note that the screw does not rotate in the process)
- Insert the filter stand and fasten it with the knurled screw in the hole provided (No.6)
- Choose the desired height for both platforms (No.7)
- Brew some amazing coffee

**ATTENTION:**

Make sure that the cable connections will not be damaged during the assembling. Be careful during the entire process.

Declaration of Conformity

Manufacturer: **Thuner Kaffeemaschinenfabrik GmbH**
Address: Kasernenstrasse 5
3600 Thun
Switzerland

Device Name: **TONE TOUCH 03**

Model Type: 20.0422

Function: Coffee Machine

We herewith declare under our sole responsibility that the above mentioned device meets all the provisions of the following EC Council Directives and Standards. All supporting documentations are retained under the premises of the manufacturer.

DIRECTIVES

General Applicable Directive:
Machinery Directive 2006/42/EC

Applied Harmonized Standards, National Standards or other Normative Documents:
EN 60335-1:2012 , EN 60335-2-15:2016 + A11:2018 , EN 60335-2-75:2004 + A1:2005 + A11:2006
+ A2:2008 + A12:2010 , EN 55014-1:2017 , EN 55014-2:2015 , EN IEC 61000-6-2:2019 ,
EN 61000-6-3:2007

Date CE Mark was affixed: 25. May, 2020

From Serial Number: 00020

Place, Date: CH-3600 Thun, 25. May, 2020

Signatures:



Name: Dr. Markus Widmer

Function: CEO

TONE

TONE Kaffeemaschinen AG
Kasernenstrasse 5
3600 Thun
Switzerland

+41 52 620 06 06
contact@tone-swiss.com
www.tone-swiss.com

A electronic version of these operating instructions is available at www.tone-swiss.com
A printed version can be ordered at service@tone-swiss.com.